

FOR INVESTA AIR JET

W06

2200 - (SELVEDGE)

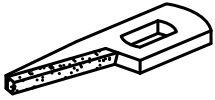

● 2203
623745-70

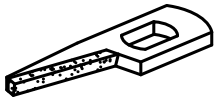

● 2204
623765-71

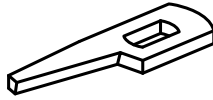

● 2201

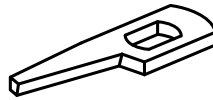

● 2202

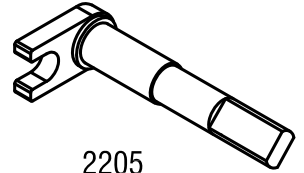

2205
SHAFT

2220 - (WEFT)

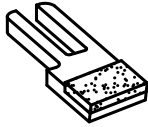

● 2221
30-54-603-049

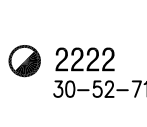

● 2222
30-52-717-309

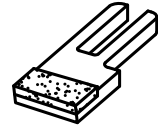

FOR DRAPER AIR JET

2810 - (TUCK IN SELVEDGE RH & LH)

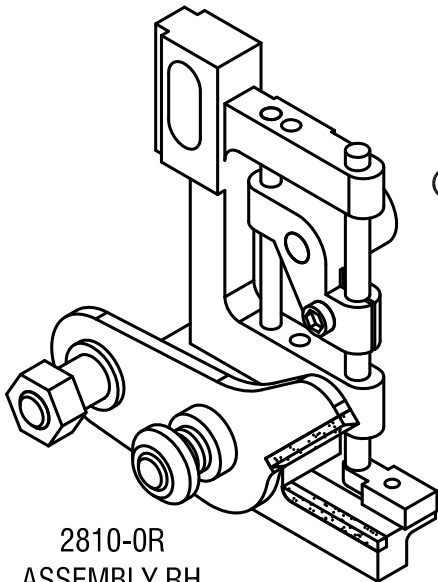

2810-0R
ASSEMBLY RH

● 2811 + 2812 R
120411+120412
CUTTER SET RH

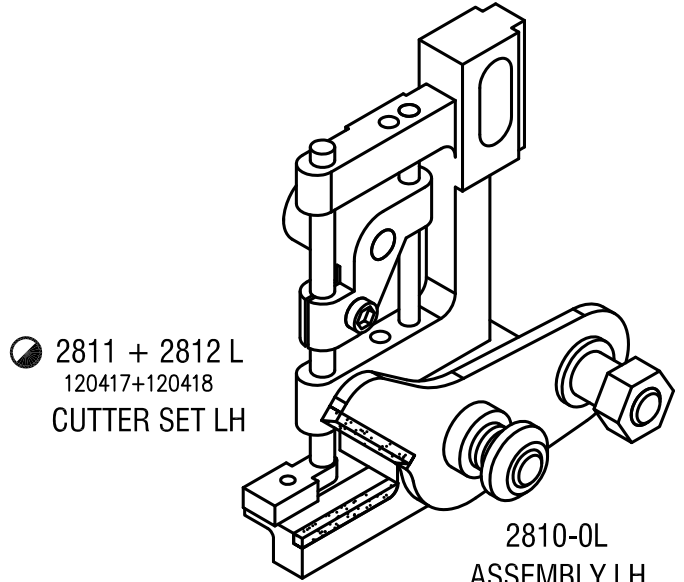

2810-0L
ASSEMBLY LH

● 2811 + 2812 L
120417+120418
CUTTER SET LH

2820 - (WEFT)

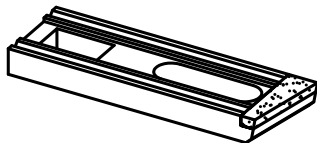

● 2822
120418

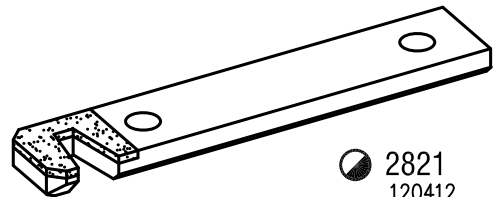

● 2821
120412

FOR JETIS AIR JET

2500 - (SELVEDGE)

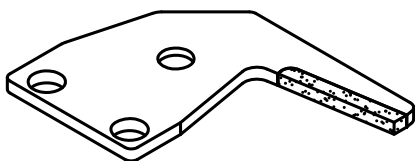

● 2502

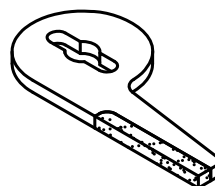

● 2501

MATERIAL CODE : ● SOLID CARBIDE , ○ HSS , ◐ BRAZED CARBIDE , ⊙ TIN COATED