

2370 - (TUCK IN SELVEDGE)



● 6072
B 158982



● 6071
B 158983



● 2373
B 96950

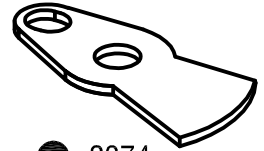

● 2374

● 2372

● 2371

● 6073
B 96950

● 6074

6070 - (TUCK IN SELVEDGE)

2380 - PAT A2H (WEFT)

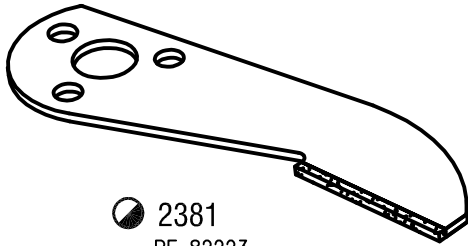

● 2381
BE 82223

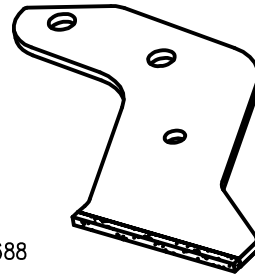

● 2382
BE 89688

2390 - (WEFT)

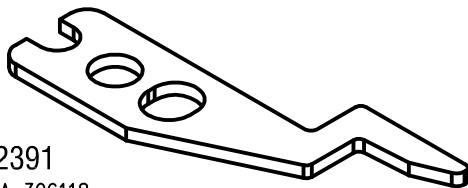

● 2391
BA 306118
BA 312909

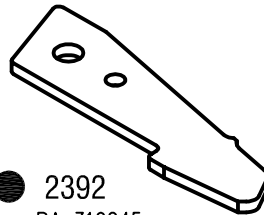

● 2392
BA 310245

6000 - (GTX - 8 - J)

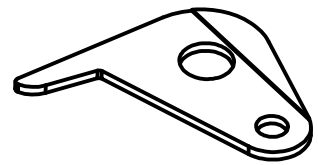

● 6001

2900 - (TUCK IN SELVEDGE)

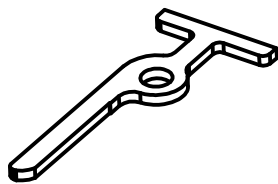

● 2901
BA 312939

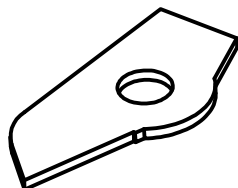

● 2902
BA 312945

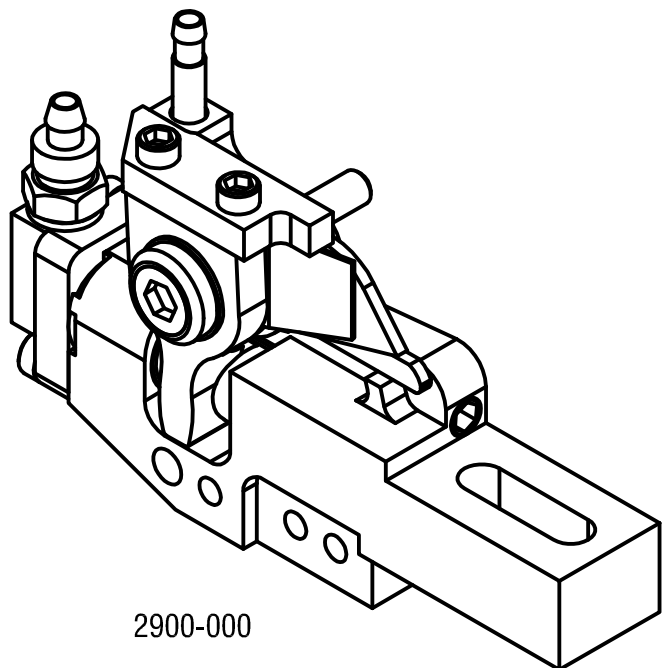

2900-000

MATERIAL CODE : ● SOLID CARBIDE , ○ HSS , ◐ BRAZED CARBIDE , ⊙ TIN COATED