

FOR SULZER AIR JET

W29

2400 - L5000 (WEFT)

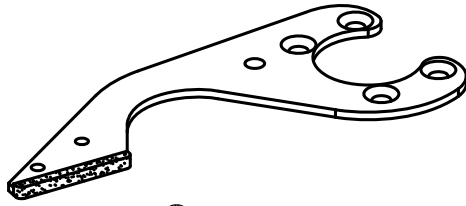

● 2401

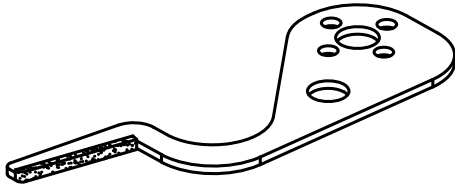

● 2402

2410 - L5000 WEFT MIXER (WEFT)

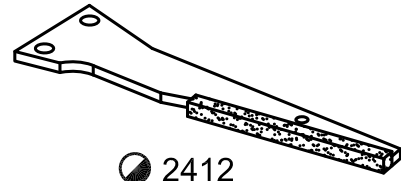

● 2412

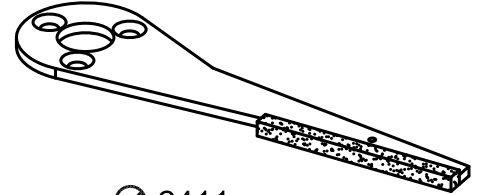

● 2411

2420 - L5000 (SIDE)

● 2421

● 3441

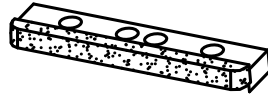

● 2422

● 3442

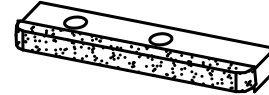

3440 - (MOTORIZED SELVEDGE)

2430 - L5100 (WEFT)

● 2432

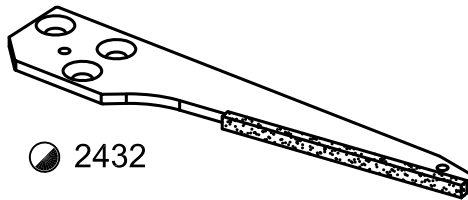

● 2431

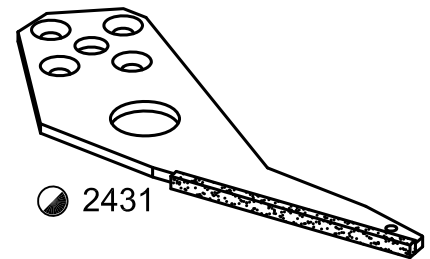

2470 - L5100 (SELVEDGE RH)

● 2472

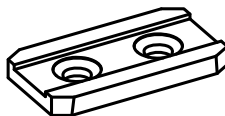

● 2471

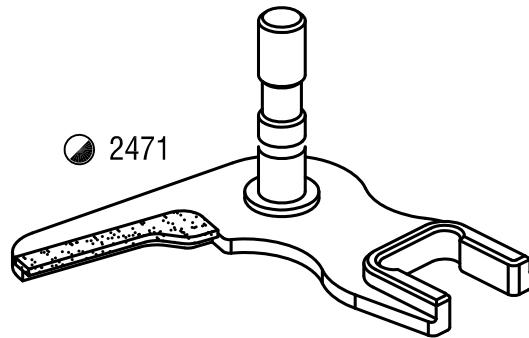

2480 - (TUCK IN SELVEDGE)

J5304-49011-00

2480-00 (2580)

SCISSOR ASSEMBLY

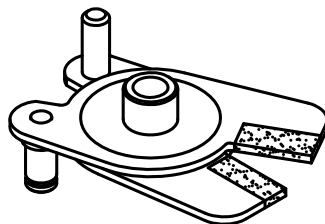

2490 - (TUCK IN SELVEDGE) L5500

● 2491 M2

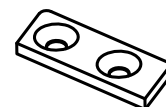

MATERIAL CODE : ● SOLID CARBIDE , ○ HSS , ◐ BRAZED CARBIDE , ⊙ TIN COATED