

2440 - L5200 (SELVEDGE RH)

● 2441

JB351 - 05199

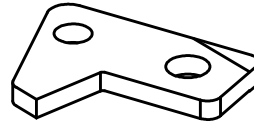
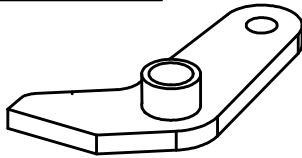

● 2442

JB351 - 06199

2450 - L5200 (WEFT SHORT)

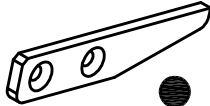

● 2452(2552) M2

JC352 - 06199 - A

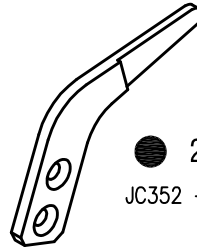

● 2451(2551) M3

JC352 - 07199 - D

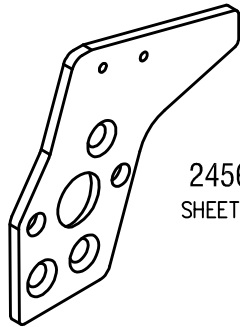

2456A
SHEET METAL

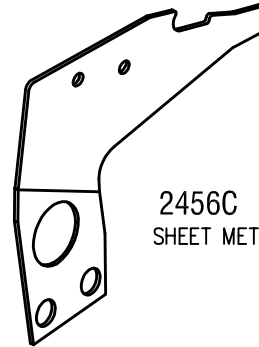

2456C
SHEET METAL

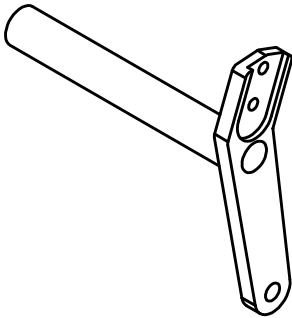

2455A M3

2465A M2
SHAFT

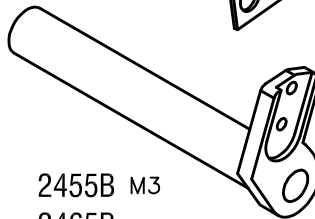

2455B M3

2465B M2
SHAFT
J1205-03020-00

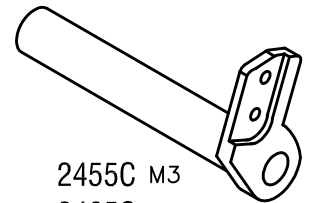

2455C M3

2465C M2
SHAFT

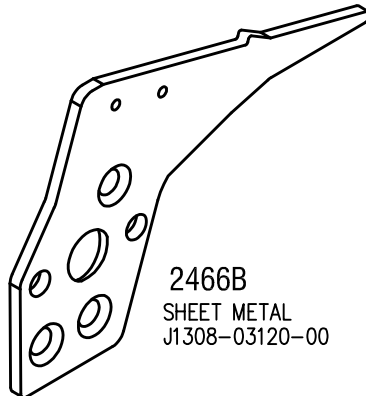

2466B
SHEET METAL
J1308-03120-00

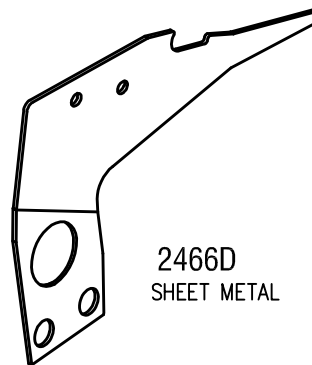

2466D
SHEET METAL

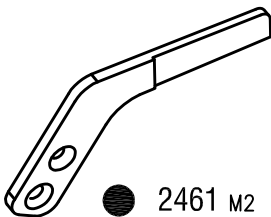

● 2461 M2

J1305-02050-00

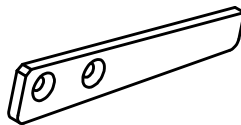

● 2462(2562) M2

J1308-02040-00

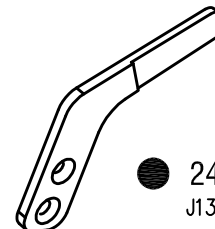

● 2463 M2

J1305-02050-00

2460 - L5200 (WEFT LONG)

MATERIAL CODE : ● SOLID CARBIDE , ○ HSS , ◐ BRAZED CARBIDE , ⊙ TIN COATED