

PAWAN T series suction guns are designed to handle yarns at very high speeds (upto 8000 mtr/min) for POY / FDY application. Various models available for handling variety of yarn sizes.

PAWAN 750T



SPECIFICATIONS

OPERATING PRESSURE : 6-14 BAR (kg/cm ²)
YARN SPEED RANGE : upto 8000 mtr/min
YARN COUNT POSSIBILITIES : 3200 (dtex)
WORKING PRINCIPLE : TWISTING
AIR SUPPLY CONNECTION : 25 mm ID HOSE
AIR EXHAUST CONNECTION : 32 mm ID HOSE
AIR CONSUMPTION : 52X(BAR+1) m ³ /hr.
OVERALL DIMENSION : 402X85X42 mm
WEIGHT (WITHOUT HOSE) : 1.30 kg

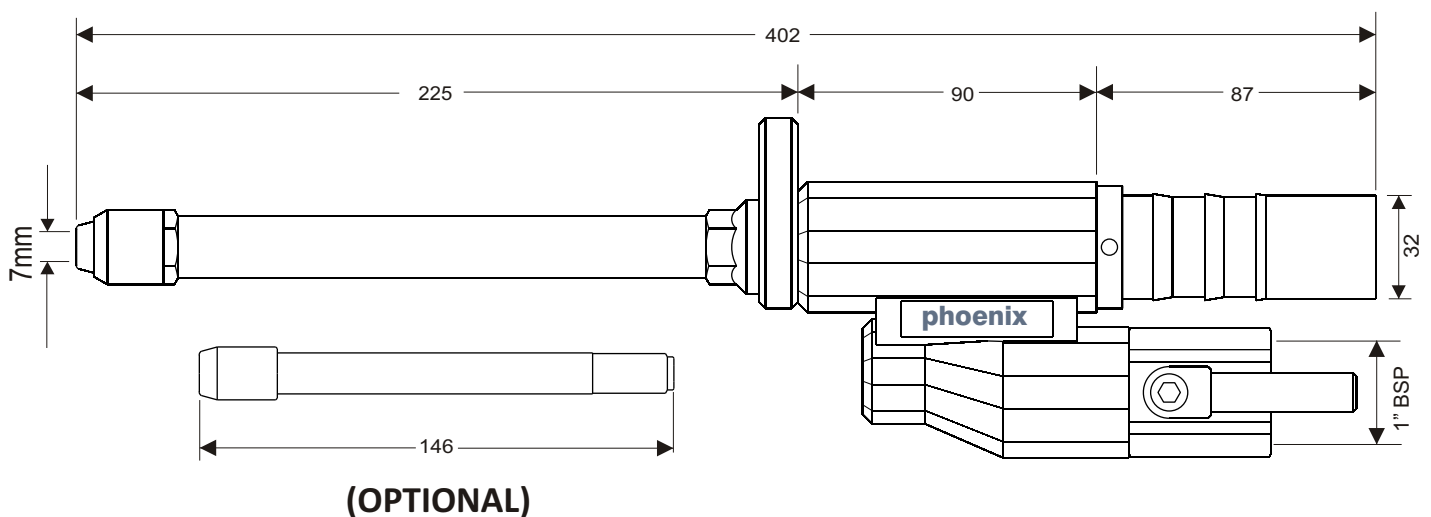

Other modifications on request

REPLACEMENT FOR : HEBERLEIN HS7