

PAWAN U series is a modified version of PAWAN S series of suction guns. With a new configuration of nozzle & chamber, the performance equivalent to PAWAN S is achieved with about 20% less air consumption. PAWAN U guns are widely used on high speed spinning machines (upto 5500 mtr/min). Various models available for handling variety of yarn size & speed.

PAWAN 500U



SPECIFICATIONS

OPERATING PRESSURE :	5-10 BAR (kg/cm ²)
YARN SPEED RANGE :	upto 5500 mtr/min
YARN COUNT POSSIBILITIES :	1600 (dtex)
WORKING PRINCIPLE :	TWISTING
AIR SUPPLY CONNECTION :	20 mm ID HOSE
AIR EXHAUST CONNECTION :	30 mm ID HOSE
AIR CONSUMPTION :	38(BAR+1) m ³ /hr.
OVERALL DIMENSION :	396X75X42 mm
WEIGHT (WITHOUT HOSE) :	1.10 kg

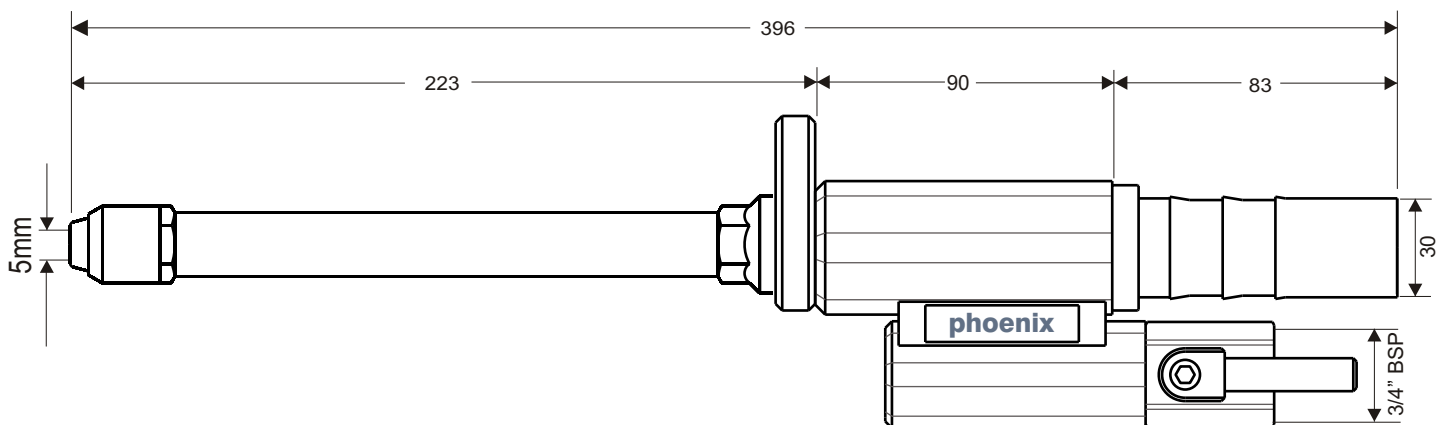

Other modifications on request

REPLACEMENT FOR : HEBERLEIN LC5